

1-800AWNINGS.com

RETRACTABLE AWNING INSTALLATION RESOURCE GUIDE



Shademaker[®]
— RETRACTABLE AWNINGS —

GENERAL AWNING INSTALLATION PROCEDURES Before You

Begin - PG. 1	.
General Awning Installation Procedures.- PG. 2-9	.
Pitch Adjustment: ZEUS (Minor) - PG. 10	.
Pitch Adjustment: ZEUS (Major) - PG. 11	.
ZEUS Soffit Mount and Hood Assembly Notes - PG. 12	.
Pitch Adjustment (ALL MODELS) - PG. 13	.
Pitch Adjustment (DROPSHADE ONLY) - PG. 14	.
Center Support Adjustment: ZEUS - PG. 15	.
Pitch Adjustment: APOLLO - PG. 16	.
Elbow Adjustment: APOLLO - PG. 17	.
Front Bar Adjustment: APOLLO - PG. 18	.
Installing Manual Override Stem: APOLLO - PG. 19-22	.
Wrist Adjustment: APOLLO - PG. 23 - 25	.
Important Motor Notice - PG. 26	.
Motor Programming: All Models - PG. 27 - 28	.
Sunea RTS CMO Visual Reference Guide - PG. 29	.
Somfy Eolis 3D Wind Sensor Programming Guide - PG.30 - 32	.
Somfy Eolis 3D Wind Sensor Troubleshooting Guide - PG. 33	.

OFFICE: 800-296-4647 M-F (7am - 3:30pm EST)



AN AWNING INSTALLATION IS A HOME IMPROVEMENT PROJECT REQUIRING STRICT ADHERENCE TO THE ENCLOSED INSTRUCTIONS AND WARNINGS.

IF AFTER READING THE INSTRUCTIONS, YOU HAVE ANY QUESTIONS, OR DO NOT POSSESS A FULL UNDERSTANDING OF THE TECHNIQUE AND/OR ABILITY REQUIRED TO SAFELY INSTALL AND OPERATE YOUR AWNING, DO NOT PROCEED.



Support & Questions

If you have any questions, problems, or need additional parts, please contact 1-800Awnings.com tech support at:

800-296-4647



WARNING: ALWAYS CLOSE the awning during high or gusting winds, rain and when not in use. Failure to do so may result in personal injury, property damage, or even death.

WARNING: Extension arms are under high tension and can cause serious damage or injury if disassembled or repaired improperly. NEVER LAY, SIT, STAND OR PLACE ANYTHING HEAVY ON THE AWNING!

INSTALLATION GUIDELINES

BEFORE YOU BEGIN - Please read completely

By carefully reading these instructions you will reduce your installation time while providing a safe, worry-free addition to your home. Contained within these instructions are the basic installation guidelines for a typical mounting surface. The installation of this product typically takes two people with basic carpentry skills about two hours to install. A third person, to help carry the unit up the ladder and place into the installation brackets, will add to the safety of the installation and is highly recommended. Incorrect installation and operation of your shading system may result in product failure and possible injury, which is not covered under warranty. Please carefully read this entire document BEFORE attempting your installation. Improper installation can cause damage to the product, your home and compromise the safety of those under or near the awning.

WHAT YOU NEED BEFORE YOU BEGIN

The correct lag screw length is determined by your mounting surface and mounting method.



LAG SCREW GUIDELINE

The total number of lag screws and flat washers needed is based on the awning size, model, and mounting application.

Number of lag screws and washers needed - two per bracket are required (galvanized hardware is recommended):

<i>Unit Width</i>	<i>Wall/Soffit Mounting</i>	<i>Roof Mounting</i>
Up to and including 12'11"	6	9
13' to 19'11"	8	12
Over 20'	12	18

Determining Proper Lag Screw Length*:

Roof Mount: 4"

Soffit Mount: 4" to 6" - depending on the amount of compressible material needed to be removed.

Wall Mount: 4" to 6" - depending on mounting surface and the amount of compressible material needed to be removed (foam insulation, vinyl siding, etc). You will be removing all material behind the installation brackets that can compress and compromise your installation.

* This is only a guideline, your application may vary. If you have questions please call us.

You may also need caulk to ensure a weatherproof seal around your installation brackets, a paintable or color matching caulk should be used - two tubes is typical sufficient.



INSTALLATION TOOL LIST

- Tape measure
- Stud Finder
- Eye protection
- Level
- Chalk Line/Laser Level
- Sockets and ratchet sets
- Rubber Mallet
- Suitable Ladder(s)
- A helper
- Vinyl Siding Tool
- Electric Drill
- Set of Allen wrenches
- Utility Knife
- Philips #2 screw driver
- Broom/Cleaning Supplies
- 1/8" drill bit for pilot holes
- Dremel/Rotozip
- Caulking gun and appropriate caulk for the job
- If the unit has an optional hood you'll need 5mm Allen wrench and a 13mm box wrench

DETERMINE YOUR MOUNTING APPLICATION

Wall, Soffit or Roof Mount application based on mounting height requirements. Please review, "Site Preparation" BEFORE making your final decision. Once the decision is made, you can move forward with determining the correct length lag screws.

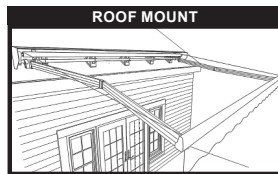
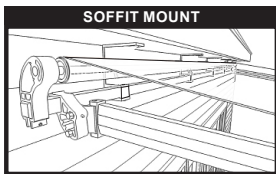
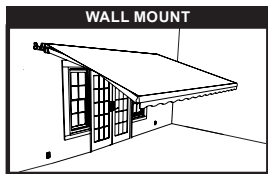

Your goal is to mount the installation brackets to the most solid part of the structure available. When installing (on any surface) you want no less than 2 1/2" of lag penetration into the stud, roof rafter or floor joist. Anything less than the 2 1/2" will compromise the integrity of the installation.

SITE PREPARATION

Before you proceed, it's best to understand the product terms and important dimensions noted in this document:

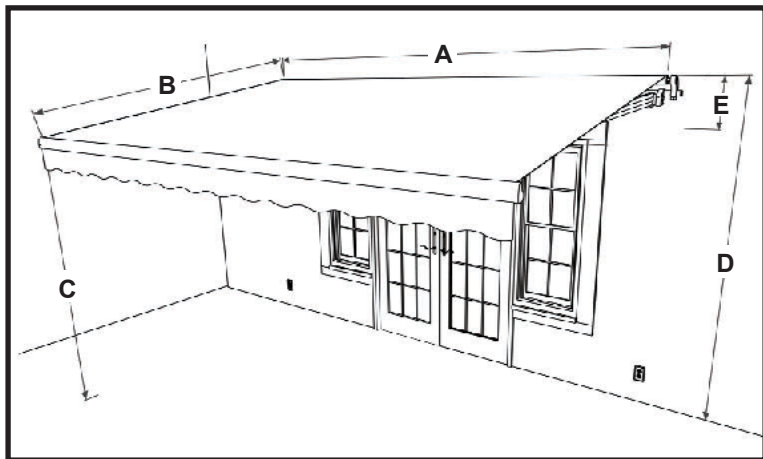

A: Unit Width: the unit width is the overall width of the unit end to end. The fabric will be 4 to 6 inches NARROWER than the overall width.

B: Projection: the distance along the roofline that the unit will travel when fully extended.

C: Front Bar Height: The distance from the ground to the bottom of the front bar. This measurement is typically set at 7'0" from the deck surface.

D: Mounting Height: The distance from the top of the installation bracket to the ground or decking surface.

E: Unit Clearance: From the top of the install bracket to the bottom of the arm when retracted. You'll need a minimum of 8" of clearance - this includes any door that opens out, casement windows, vents, exterior mounted lights, etc.

*See **minimum mounting heights** on page 4.

These are the **minimum mounting heights**, as measured straight up from your deck or patio surface:

Awning Projection	Minimum Height
5'0"	8'0"
7'4"	8'2"
8'2"/9'0"	8'2"
10'0"/10'6"	9'0"
11'6"	9'6"
13'0"	9'6"
14'9"	10'0"
16'6"	10'6"

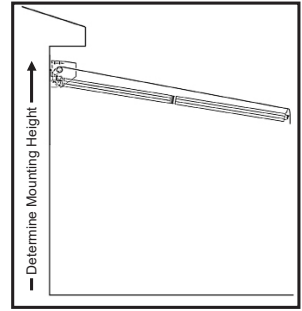

Once your location and mounting style has been determined, review the area, confirming that you have a clear span for the entire width of the awning with no light fixtures, downspouts, doors that open out (onto the deck or patio) or any other obstructions. If you are wall or soffit mounting your unit and you have a door or

window that opens out, you will need a minimum of 12" of clearance between the top of the mounting bracket and the top of that door or window to clear the awning framework and 16" to clear the fabric valance when retracted.

PRODUCT HANDLING

Your shading system has been assembled, tested, packaged, and shipped with care by skilled craftsmen - right here in the USA. Please be careful when removing the unit from the box as to prevent damage - avoid dropping or dragging the unit.

DO NOT remove the clear plastic wrapping around the actual awning until you are ready to place it into the installation brackets. This step will greatly reduce soiling or damaging of the fabric. When it is time to place the awning into the installation brackets, be careful removing the clear plastic wrapping as to NOT cut into the fabric - scissors rather than a razor is suggested.



GENERAL INSTALLATION BRACKET PLACEMENT

Before you start attaching brackets to the house, you need to take measurements. There are certain "dead areas" of the awning where either the end bracket or the arm shoulder will impede the square torsion bar from being inserted into the installation brackets. Begin this process by matching the width of the awning to the area of the house designated for installation. Mark with a pencil where the awning will go end to end, then with the use of a stud finder, determine and mark the location of all of the available studs or roof rafters between your awning width marks.

Helpful hint: On roof mounts, you can sometimes lift up the ends of the roof shingles and see the tail ends of the rafters. Next, measure the awning's square torsionbar and take the dead areas and transpose them on to the house - this is where no brackets

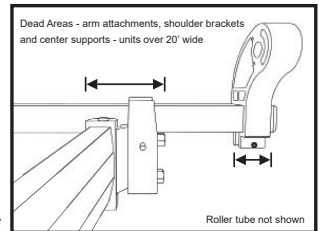

can go. Make sure you are taking the measurements assuming the torsion bar is facing the house, the arms are underneath the awning and the front bar of the awning is facing away from the house. Once you figure out where you can put brackets on the wall -match them up with where you can put them on the awning. Do your best to "sandwich" each arm shoulder for maximum strength. The best location for the install brackets is no less than 8" and no more than 16" to both sides of the arm shoulder. Once the awning is in the brackets you will be able to make some side to side adjustments if needed.

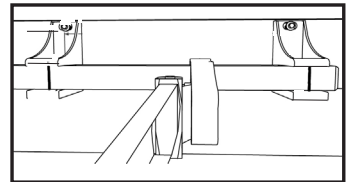

WALL MOUNTING

Installing on Clapboard:

Clapboard is usually nailed to the wall studs and in general, the studs are very easy to find. Locate the nail heads in the clapboard (they should be 16" on center) and you will have located the studs. With all of your measurements indicated on the wall as described earlier, hold up your first bracket, mark the wall, and probe for the center of the wall stud using a 1/8" drill bit. The bracket will most likely cover the extra holes which you should caulk before mounting the bracket. Once the center of the stud has been located, pre-drill a 1/4" hole the length of the lag screw - remember your goal is to get into the wall stud a minimum of 2 1/2" while not splitting the stud. Remove the bolt from the bracket and attach it to the wall using a washer and

lag screw – but do not fully tighten. Next with your level, square up the bracket and pre-drill for the second hole. Once the second hole is drilled and the lag is started, you can proceed with tightening two lag screws, avoid over tightening and stripping out the stud. Proceed in the same fashion for the rest of the brackets. Proceed to **SECURING THE AWNING IN THE BRACKETS** section.

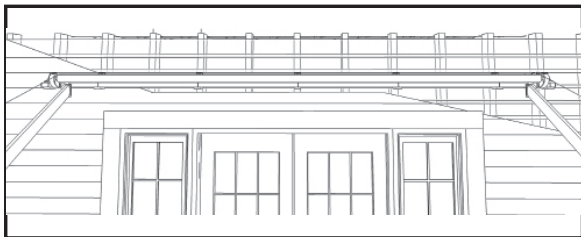
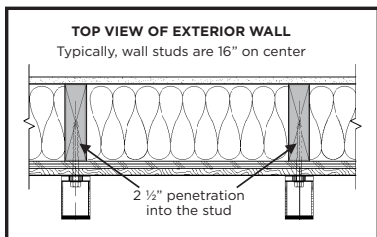

INSTALLING ON VINYL & ALUMINUM SIDING

To find the studs it may be necessary to remove or unzip the siding in the mounting location. With all of your measures indicated on the wall as described earlier, hold up your first bracket, mark the wall, and probe for the center of the wall stud using a 1/8" drill bit – the bracket will most likely cover the extra holes which you should caulk before mounting the bracket. Now that the exact location of the bracket is determined, reinstall any unzipped siding if not already reinstalled, and draw a line around the perimeter of the bracket on the siding. You will need to cut through the vinyl or aluminum siding and remove all compressible material. You should get down to the exterior wall sheathing for a solid mount. For this application you will need to build out the surface even with your siding. Most homeowners will cut up a pressure treated 2 x 4 the size of the bracket and drill two 1/2" holes allowing the lag screws to pass through. With the build out block and installation bracket in place, pre-drill a 1/4" hole the length of the lag screw – remember your goal is to get into the wall stud a minimum of 2 1/2" while not splitting the stud. Remove the bolt from the bracket and attach it to the wall using a washer and lag screw – but do not fully tighten. With your level, square up the bracket and pre-drill for the second hole. Once the second hole is drilled and the lag is started, you can proceed with tightening two lag screws, avoiding over tightening and stripping out the stud. Caulk around the bracket covering the edge of the siding to create a weatherproof seal. Proceed in the same fashion for the rest of the brackets. Proceed to **SECURING THE AWNING IN THE BRACKETS** section.

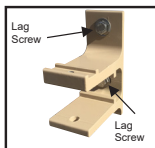

INSTALLING ON BRICK OR MASONRY

This installation requires the use of a masonry drill bit and special mounting hardware. You may want to consider using a liquid fastening system such as Hilti's HIT System™ – check with your local hardware store. DO NOT drill into your wall until you have determined your fastening system. When determining mounting location, NEVER fasten to the top two levels of brick and avoid drilling into the mortar – you want to drill into the center of the brick whenever possible. Make sure you use a level, don't assume that the bricks are level. Some brick faces are not structural, but are facades only. If this is the case, make sure your fasteners are penetrating into the structural members behind the brick face.

Once your fastening system has been determined and all of your measurements are indicated on the wall as described earlier, hold up your first bracket, mark the wall, and drill into the brick or masonry with your masonry bit deep enough to fully house the lag shields or anchoring system. Remove the bolt from the bracket and attach it to the wall using a washer and hardware – but do not fully tighten. Next, with your level, square up the bracket and pre-drill for the second hole. Once the second hole is drilled and the fastener is started, you can proceed with tightening both bolts, avoiding over tightening. Proceed in the same fashion for the rest of the brackets. Proceed to **SECURING THE AWNING IN THE BRACKETS** section.

INSTALLING INTO DRIVIT™ STYLE FINISHES

Using a stud finder, determine the location of the wall studs. With all of your measurements indicated on the wall as described earlier, hold up your first bracket, mark the wall and probe for the center of the wall stud using a 1/8" drill bit – the bracket will most likely cover the extra holes which you should caulk before mounting the bracket. Once the center of the stud is determined, take the installation bracket and trace the footprint on the wall. Using a Sawzall or Rotozip, proceed to cut out the surface and all foam until you get all the way to the plywood sheathing. Note: avoid using a battery powered hole saw, typically the speed is not sufficient and if you catch the chicken wire mesh underneath it may tear causing visual damage to the wall surface.

For this application, you will need to build out the surface even with your wall finish. Most homeowners will cut a "build out block" from a pressure treated 2" x 4" the size of the bracket and drill two 1/2" holes allowing the lag screws to pass through. With the build out block and installation bracket in place, pre-drill a 1/4" hole the length of the lag screw - remember your goal is to get into the wall stud a minimum of 2 1/2" while not splitting the stud. Remove the bolt from the bracket and attach it to the wall using a washer and lag screw - but do not fully tighten. Next, with your level, square up the bracket and pre-drill for the second hole. Once the second hole is drilled and the lag is started, you can proceed with tightening two lag screws, avoiding over tightening and stripping out the stud. Caulk around the bracket covering the edge of the finish to create a weatherproof seal - you DO NOT want to allow moisture to get into any openings you created. Proceed in the same fashion for the rest of the brackets. Proceed to SECURING THE AWNING IN THE BRACKETS section.

SOFFIT MOUNTING

Installing To A Soffit (under an eave or overhang):

Prepare the area by opening the soffit to determine if solid mounting can be achieved by attaching to the roof rafters or other structural framing. If solid mounting is available, mount directly to the soffit. If the ends of the roof rafters are near, but not extending to the soffit surface you may want to use a 2" x 8" header board across the rafter ends to build out the area. When mounting a header board, pre-drill 1/4" holes to avoid splitting of the board and rafters; apply two lags to every other rafter. Make sure your lags get at least 2 1/2" into the rafters. Once the header board is built out even with the bottom of the soffit, replace the soffit covering and install the mounting brackets through the covering and into the header board.

With all of your measurements indicated on the soffit cover as described earlier, hold up your first bracket, mark the soffit cover, and probe for the center of the stud using a 1/8" drill bit (if you just installed a header board you can skip this step) - the bracket will most likely cover the extra holes which you should caulk before mounting the bracket.

Once the center of the stud has been located, pre-drill a 1/4" hole the length of the lag screw - remember your goal is to get into the wall stud a minimum of 2 1/2" while not splitting the stud. Remove the bolt from the bracket and attach it to the wall using a washer and lag screw - but do not fully tighten. Next, with your level, square up the bracket and pre-drill for the second hole. Once the second hole is drilled and the lag is started, you can proceed with tightening two lag screws, avoiding over tightening and stripping out the stud. Proceed in the same fashion for the rest of the brackets. Proceed to SECURING THE AWNING IN THE BRACKETS section.



ROOF MOUNTING

IMPORTANT NOTE 12" BRACKETS: FOR USE WITH ZEUS - YOU WILL NEED TO DRILL 4 HOLES ON THE FACEPLATE

Additional Required Tools: 3/4" wrench, Metal blade saw, and 2 tubes of roofing cement

On the roof, mark the width of the awning and the outer boundaries of the usable rafters. Some rafters may fall where the arms or center support are mounted to the torsion bar. Transpose the "dead mounting areas" and determine which rafters you can attach to. To locate the rafters, some will use a framing hammer and listen as they bang.

Do your best to bookend each shoulder for maximum strength. The best location for the install brackets is no less than 8" and no more than 16" to both sides of each arm shoulder. On smaller units, their may be as few as three installation brackets. In these cases, try in install a bracket within 16" on each end of the awning and place the third bracket near the middle.

Place the three-hole base of the roof mount bracket 3"- 5" back on the roof. Mark with a chalk line so that all of the brackets will be in line. *PRO TIP: Some installers use the bottom edge of the 2nd row of shingles as a mounting guide as where to line up the bottom of the plates.*

Pre-drill 1/4" holes for 3/8" lags (make sure each time you drill you have a solid rafter to mount to).

Fill all holes, and the back of the bracket with roofing cement or silicone caulk - [see A](#).

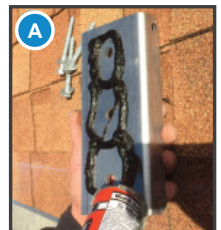

Lag the three-hole face plate to the roof rafters. The lag needs to hit the center of the roof rafter and go in straight, at least 3 1/2" to 4 1/2" deep into rafter. To achieve this you need 4 to 6 inch long lag screws. **See B1 & B2.**

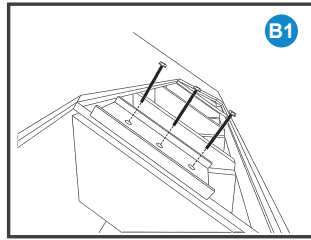

Assemble the rest of roof bracket and mount the installation bracket to the face plate. The install bracket should be as close to level as possible or leaning back slightly. The install bracket should never lean forward. **See C1, C2 & C3.**

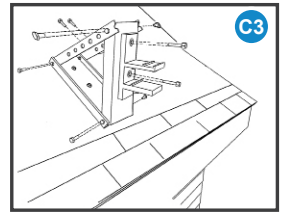

Trim off the extra side straps and caulk around the base of the bracket, then with the hardware provided, attach install brackets making sure the install bracket is plumb using a 6" level. **See D1 & D2.**

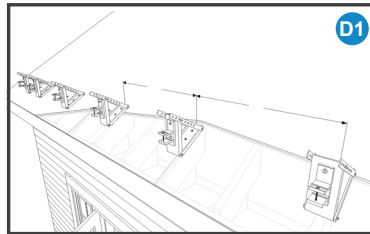

A fully installed Roof Mount Bracket. **See E.**



SECURING THE AWNING INTO THE BRACKETS

Once all the installation brackets are securely fastened to the wall, check again that they are level - you don't want to find this out while you are on your ladder with a 200 lb awning in your hands.

Like your mother always said, "wash your hands!" before proceeding. Clean hands will not leave marks on the awning fabric and will greatly reduce clean up time.

Take the awning out of the clear plastic covering using a scissor and cutting away from the fabric - not a razor.

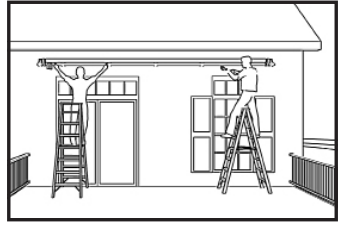

With the arms facing down and fabric roller on top, you and your assistant(s) carefully walk the unit up the ladder and place the square torsion bar into the installation brackets. You should use some side to side movement to help place the awning in the desired location. Once securely in the brackets, reinstall the installation bolts and fully tighten - DO NOT operate the awning until these bolts have been fully installed.

OPERATION

Motors and Controls (optional):

Your unit has the optional motor with a weather proof, UL listed plug-in cord - either 12' or 24' based on what you selected. Simply plug the cord into a GFI receptacle. The remote control, which is provided, will now operate the opening and closing of your awning. Your awning shipped with a motor override stem in a bag - about 4" long. The crank handle, also provided, The override stem is installed into the head of the motor (on the drive side) and secured with a washer and 3mm allen wrench from the top of the motor.

To manually operate your awning, place the crank handle "hook" into the override stem "eye" and turn the crank handle.



Override stem - runs through the motor head and is secured from the top.



Your hand held remote control comes equipped with mounting hardware.



WARNING!

Be sure that the unit is fully installed with all mounting hardware and installation bolts secured before using the remote control.

Manual Gear Operation:

Once your awning is fully installed with all mounting hardware and installation bolts secured, you may operate the unit. To extend the awning, place the hook end of your crank handle into the gear loop located at the far end of the awning. Turn the hand crank in a circular motion until the awning is fully extended and the arms "lock" in place, then turn the crank in the opposite direction to properly tension the awning. Please note that when the awning is fully extended the arms will not be straight.

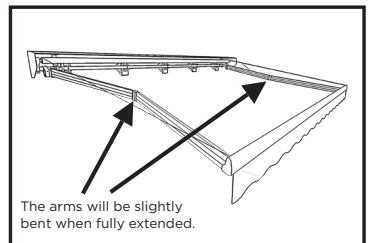

DO NOT OVEREXTEND THE AWNING.

If you continue to unwind fabric off the roller tube, the fabric will sag and eventually start to roll up from the under side of the roller tube. This can cause the fabric to come out of alignment or damage the fabric. The fabric should always roll over the top of the roller tube. To retract the awning, simply repeat the process, turning the hand crank in the opposite direction until the awning is fully:

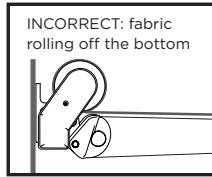
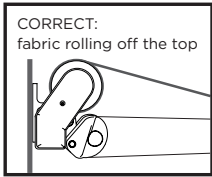

PROTECTIVE HOOD (optional)

Hood Assembly & Installation *(For ZEUS hood assembly, please see page 14.)*

Unbox the hood, side covers and the brackets. Lay the hood on its back with the tracks facing up. Choose a surface that will not damage the painted finish.

Slightly loosen the 13mm hex head bolts from the aluminum plate on the hood brackets provided. Slide the 3/4" x 4" aluminum plate into the groove of the hood. There is the letter "F" on this aluminum plate that should be facing the front (the curved side) of the hood – do not tighten the bolts at this time. Next remove the 5mm allen head bolt from each hood bracket – **see A**.

Next, attach the hood end covers with the Phillips screws provided. Each end cover requires 3 screws which install into screw guides in the hood. The side covers can also be installed once the hood is in place – **see B**.

The hood will be attached to the square torsion bar – the brackets slide directly down over this bar. Check the torsion bar and make a note of the unusable mounting areas such as the end brackets, arm shoulders, install brackets, and any other obstruction that will interfere with the hood brackets. These areas will not accept a hood bracket and are "dead mounting areas" and should be noted as areas where brackets cannot go – **see C**.

The first two brackets: A hood bracket should be placed no more than 2' 0" from either end. The balance of the brackets should be evenly spaced along the unit should not exceed 5' 0". Once the brackets are properly spaced (keeping in mind of the dead areas mentioned earlier), tighten the 13mm hex head bolts – **see D & E**.

With a helper, walk up the ladders and place the hood straight down onto the top of the square torsion bar. This may be done before or after the awning is installed. The protective hood is 1" longer than the awning allowing for some side to side adjustability.

With the hood in place, reinstall the 5mm allen bolts into each hood bracket. Some hood brackets may be behind the arm - if this is the case, extend the awning to allow you access.

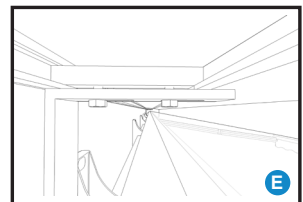
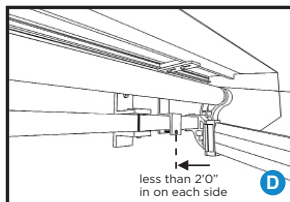
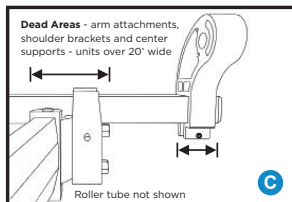
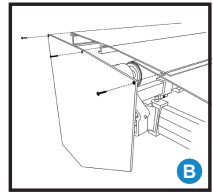
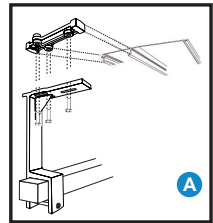

Installing to Uneven Surfaces:

We recommend using pressure treated lumber equal to the length of the awning as a header board (2"x 8" for most Shademaker models, or 2"x12" for the ZEUS).

You may choose to "wrap" the header board in matching vinyl or aluminum to give the job a finished, professional look, or you may choose to paint the header to match the trim or house.

For this method, you will also need additional lags and washers to mount the board. We suggest 2 bolts per wall stud to secure the board to the wall. If the surface is brick or stone, we suggest that you consider using the Hilti Hit System.

You will need 3" long carriage bolts, washers, and nuts to pre-mount the installation brackets to the board BEFORE you mount the board to the wall. This method should provide ideal placement of all installation brackets.

► **What to Expect:** A minor pitch adjustment typically takes around 20 minutes to perform and requires an assistant.

► **Tools Needed:**

- 6mm Allen Wrench/Socket
- (Two) 22mm Sockets/Wrenches
- Measuring Tape or a Level
- A Step Ladder
- An Assistant

Step #1 Extend the ZEUS awning fully.

Step #2 Loosen both 22mm nuts on the inside of the shoulder several turns. Repeat on other shoulders.

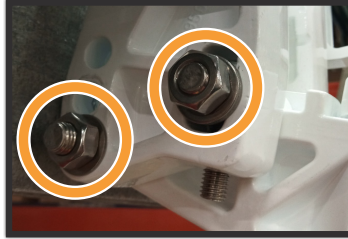

Step #3a Depending on the adjustment needed, loosen or tighten the two 6mm Allen pitch adjustment screws on all shoulders.

Step #3b When adjusting the 6mm screws, raise the front bar slightly to remove pressure from the screws.

Step #3c To Raise Pitch: Turn the 6mm Allens Clockwise.

Step #3d To Lower Pitch: Turn the 6mm Allens Counterclockwise.

***Note** Both 6mm Allen screws need to be adjusted equally.
*If desired pitch cannot be achieved, please view our ZEUS Major Pitch Adjustment video.



Step #4 When adjustments are complete, retighten the two 22mm nuts on all the shoulders.



Step #5 Confirm the front bar is level. Use a level or measure both sides of the front bar to a flat, even surface.

► **What to Expect:** A major pitch adjustment typically takes around 30 minutes to perform and requires an assistant.

► **Tools Needed:**

- 6mm Allen Wrench/Socket
- A Step Ladder
- (Two) 22mm Sockets/Wrenches
- An Assistant
- Measuring Tape or a Level

Step #1 Extend the ZEUS awning fully.

Step #2 Loosen both 22mm nuts on the inside of the shoulder several turns.

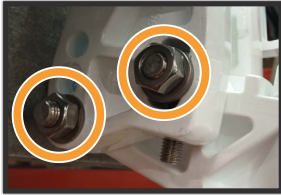

Step #3a Loosen both pitch 6mm Allen adjustment screws all the way down.

Step #3b When adjusting the 6mm screws, raise the front bar slightly to remove pressure from the screws.



Step #4 With an assistant lifting the front bar, remove the back 22mm bolt from the shoulder.

Step #5a Depending on the pitch required, replace the 22mm bolt into one of the three openings.

Step #5b **To Raise Pitch:** place the bolt in a lower slot.
To Lower Pitch: place the bolt in a higher slot.

Step #6a Hand tighten the nut on the bolt.

Step #6b **IMPORTANT:** Repeat this process on the other shoulders before final pitch adjustments.

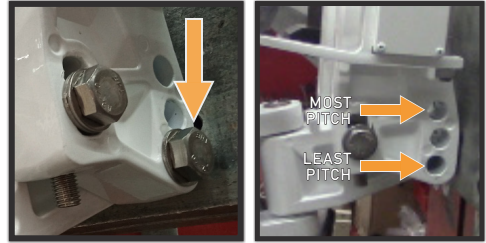

Step #7 Roll the awning out fully and with a level or a ruler, determine the desired pitch. Adjust both 6mm Allen screws in each shoulder to achieve correct pitch.

***Note** Both 6mm Allen screws need to be adjusted equally.

Step #8 When adjustments are complete, retighten the two 22mm nuts on all shoulders.



Step #9 Confirm the front bar is level. Use a level or measure both sides of the front bar to a flat, even surface.

ZEUS SOFFIT MOUNT NOTES

(ONLY SOFFIT MOUNTS WITH CENTER SUPPORTS)

When installing a ZEUS (13-0 projection) Soffit Mount, 3/4" Aluminum build out plates are REQUIRED to be installed between the install brackets and the soffit to provide clearance for the center support(s).

When installing a ZEUS Soffit Mount, the following is required for proper installation:

- A 2x10 or 2x12 header board must be used.
- (x2) 3/4" Aluminum build out plates are REQUIRED to be installed between the install bracket and the header board to provide clearance for the center support(s).
- Any installation of a ZEUS without the use of a header board voids the Manufacturer's warranty.

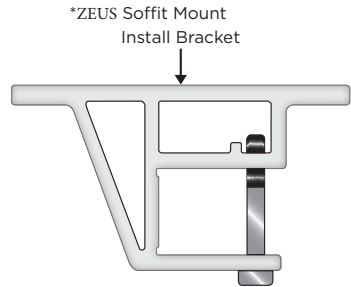
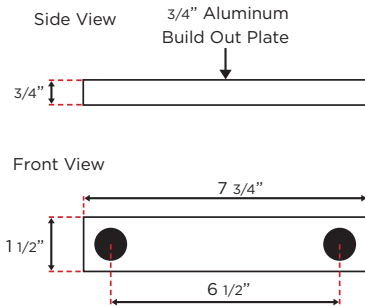

ZEUS HOOD ASSEMBLY

The procedure for assembling a standard hood (page 9) can be followed for ZEUS units for the most part, but there are some major differences to note:

The ZEUS hood brackets are slightly different.

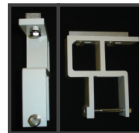

The ZEUS hood has a front and rear profile. The front profile groove fits into the rear profile and is held in place by inserting and tightening the hood clamp kit.



The ZEUS hood end covers have a 4th slot when connecting to them to the hood assembly.

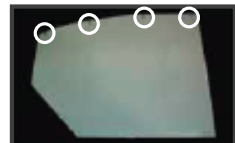

► **What to Expect:** A pitch adjustment typically takes 10-15 minutes to complete and requires 2 people.

► **Tools Needed:**

- 7mm, 8mm, & 12mm Allen Wrenches/Sockets
- A Step Ladder
- Small Flat Blade Screwdriver
- Measuring Tape or a Level
- An Assistant

Step #1 Fully extend the awning.

***Only exemption:**
11'6" projection with Drop Shade
(See Next Page)

Step #2

With a small flat blade screw driver, remove the decorative plastic caps on the front and side of the shoulders.

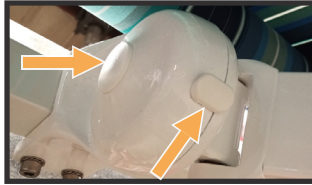

Step #3 Partially loosen, but do not remove, the 12mm Allen locking bolt on the outside of the shoulder.



Step #4 With an assistant lifting up on the arm to reduce tension, adjust the pitch by turning the 7mm or 8mm Allen front setting screw.

To Raise Pitch:

Turn clockwise or tighten.



To Lower Pitch:

Turn counterclockwise or loosen.



***Note** When the required level position has been achieved, raise the arm slightly to eliminate play in the internal mechanism.

Step #5 Repeat the process on the other arm(s), using a level or tape measure to confirm a level unit.

Step #6 Confirm the front bar is level. Use a level or measure both sides of the front bar to a flat, even surface.

Step #7 When desired pitch is achieved, completely tighten ALL 12mm Allen locking bolts and replace the decorative caps.

What to Expect: A pitch adjustment typically takes 10-15 minutes to complete and requires 2 people.

Tools Needed:

- 10mm Allen Key
- A Step Ladder
- 22mm Box Wrench
- Measuring Tape or a Level
- An Assistant

Step #1 Fully extend the awning.

Step #2

Remove the decorative plastic cap from the side of the shoulder, covering the 22mm bolt.

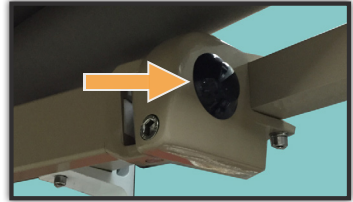

Step #3 Partially loosen (DO NOT REMOVE) the 22mm side locking bolt on the side of the shoulder.

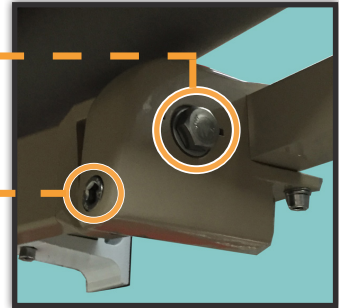

Step #4 With an assistant lifting up on the arm to take the load off the pitch bolt, use a 10mm Allen key to turn front setting screw.

To Raise Pitch: Turn the 10mm setting screw **Clockwise**.

To Lower Pitch: Turn the 10mm setting screw **Counterclockwise**.

***Note** Pitch should be adjusted from higher to lower front bar position. When the required level position has been achieved, raise the arm slightly to eliminate play in the internal mechanism and to prevent the arms from losing their level position in the future.

Step #5 Repeat the process on the other arm(s), using a level or tape measure to confirm a level unit.

Step #6 When desired pitch is achieved, completely tighten the 22mm side locking bolt and replace the decorative cap.

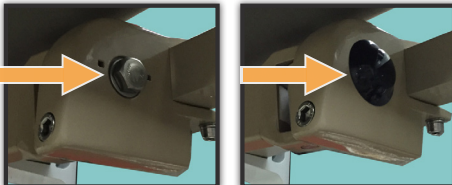

1-800Awnings.com

Questions: 800-296-4647
M-F (7am - 3:30pm EST)



If you change the pitch on this Shademaker awning, you will need to **READJUST** the Center Support. By not following these instructions you may cause untimely damage to the fabric cover. Damage caused by a Center Support is **NOT** covered by the Shademaker warranty.

*First adjust the unit's arms and level the front bar to the desired height.

*Make sure the Center Support is centered on a fabric seam - **DO NOT** shift the Center Support away from a fabric seam.

Adjusting the Center Support:

- Step #1** Extend the awning half way.
- Step #2** Slightly loosen the six, 4mm Allen screws (three on each side) that lock the black PVC cradle in place.
- Step #3** Rotate the PVC cradle so that the fabric is rolling out directly from the center of the opening.
- Step #4** Retighten all six, 4mm Allen screws.
- Step #5** Roll the unit all the way in and extend fully to make sure the fabric is not coming in contact with the cradle.

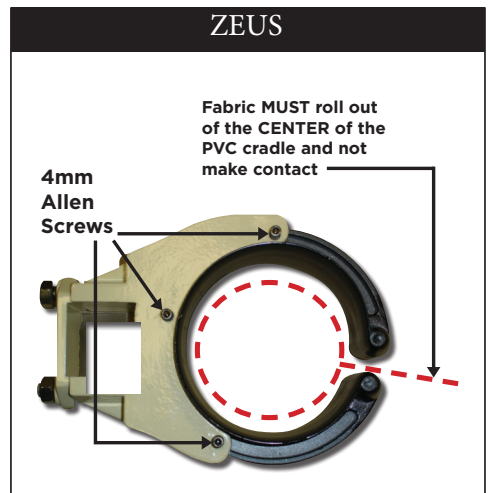

APOLLO

PITCH ADJUSTMENT

APPLIES TO SEMI & FULL CASSETTE

► **What to Expect:** A pitch adjustment typically takes 10-15 minutes to complete and requires 2 people.

► **Tools Needed:**

- 8mm Allen Wrenches/Sockets
- A Step Ladder
- Measuring Tape or a Level
- An Assistant

Step #1 Fully extend the APOLLO awning.

Step #2 With an assistant lifting the arm, rotate the 8mm Allen.

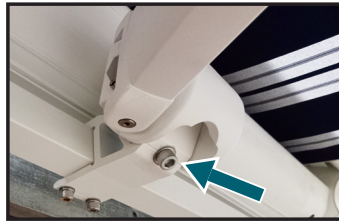

Step #3 To Raise Pitch: Turn the 8mm Allen **clockwise or tighten**.

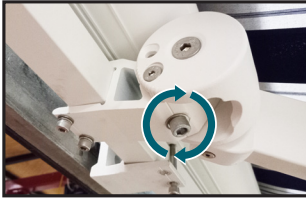

Step #4 To Lower Pitch: Turn the 8mm Allen **counterclockwise or loosen**.



Step #5 If turning the 8mm Allen is difficult, have the assistant raise the arm higher to ease tension.

Step #6 Confirm the front bar is level. Use a level or measure both sides of the front bar to a flat, even surface.

APOLLO ELBOW ADJUSTMENT APPLIES TO SEMI & FULL CASSETTE

► **What to Expect:** An elbow adjustment typically takes 15-20 minutes to complete.

► **Tools Needed:** • 4mm Allen Wrenches/Sockets • A Step Ladder

Step #1 Roll the awning all the way in and determine if the elbows need to be adjusted.

Step #2 If adjustment is needed, roll the awning out until you can access the 4mm set screw on the inside of shoulder (about ½ way out).

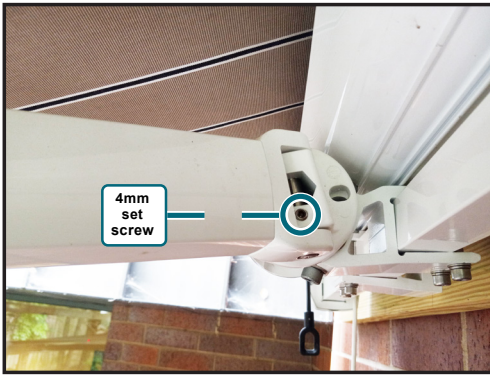

Step #3 Loosen the 4mm set screw or remove temporarily.

Step #4 Using a 4mm allen key, spin the main pin (it attaches the arm to the shoulder) one way or the other to raise or lower the elbow to desired height.

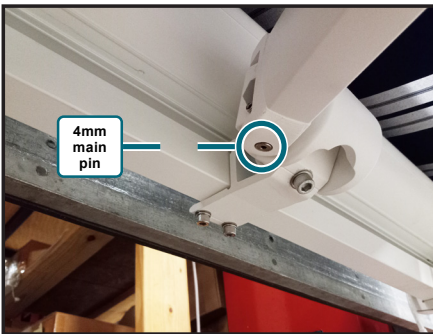

Step #5 Replace the 4mm set screw, roll the awning all the way in and check elbow placement.

APOLLO

FRONT BAR ADJUSTMENT

APPLIES TO SEMI & FULL CASSETTE

► **What to Expect:** A front bar adjustment typically takes 25-30 minutes to complete.

► **Tools Needed:** • 6mm Allen Wrenches/Sockets • A Step Ladder

Step #1 Extend the awning until it reaches the outer limit.

Step #2

Press up and down together on the remote until the awning jogs. Now roll out beyond your outer limit until the fabric is loose.



Step #3

Using a 6mm allen key, loosen the 2 wrist bolts on both sides.

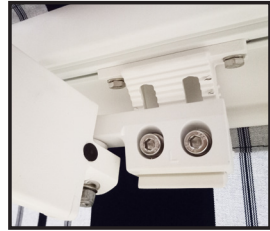

Step #4 With the wrist bolts loose on all wrists, rotate the front bar up or down to the desired position. Be sure the wrists are on the same mark on both sides.

Step #5 With the front bar in the desired position, tighten the (2) 6mm bolts on both wrists

Step #6 Roll the awning back in to the outer limit position and press and hold "MY" for 1 jog, outer limit has been reset and adjustment is complete.

Check elbow alignment:



APOLLO

INSTALLING MANUAL OVERRIDE STEM

APPLIES TO SEMI & FULL CASSETTE

► **What to Expect:** This process typically takes 20-30 minutes to complete.

► **Tools Needed:**

- 3mm, 4mm Allen Wrenches/Sockets
- 1/8" and 1/2" Drill Bits
- Phillips Head
- Rotary Saw
- Straps or Rope to secure arms
- A Step Ladder
- Rubber Mallet

Step #1 With the awning fully retracted, secure together the front and back half of all arms and secure both arms to the torsion bar.

Extend the awning one full rotation of the roller tube to ensure that the arms are properly secured.

Step #2 Remove the side cover by locating and removing the 4mm allen set screw shown here. Once the set screw is removed, you can pull the side cover off.

Semi Cassette

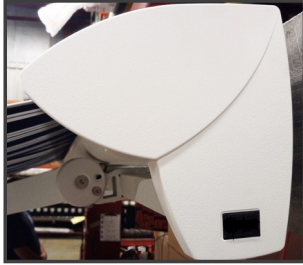

Full Cassette



Step #3 Loosen the Upper Cassette Profile by removing the 2 phillips head screws shown here. You can now lift the Upper Cassette Profile and work beneath it. You can also repeat step 2 and step 3 on the opposite side of the awning and set the entire Upper Cassette Profile aside.

Semi Cassette

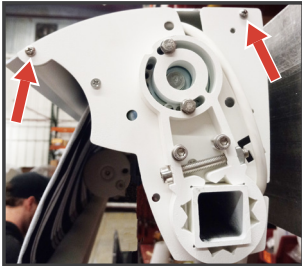

Full Cassette

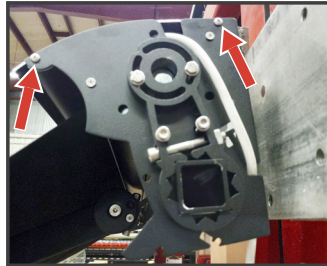

Note: The Semi Cassette model is pictured for steps 4 through 9, but the instructions apply also to the Full Cassette. The side plate just appears slightly different.

Step #4 Drop a pencil through the override hole in the motor head in order to mark where the hole will be drilled on the Fabric Protector Profile.

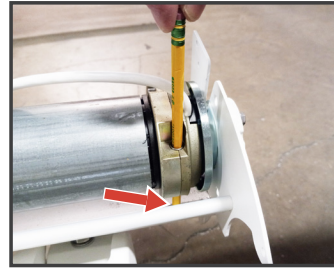
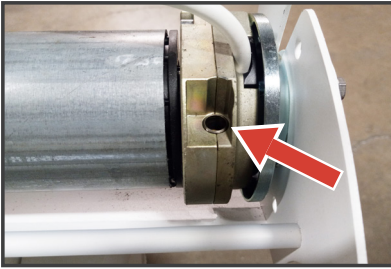

Step #5 Remove the 6mm Allen bolt and two phillips head screws shown in order to pull out the end bracket, side plate, and motor.

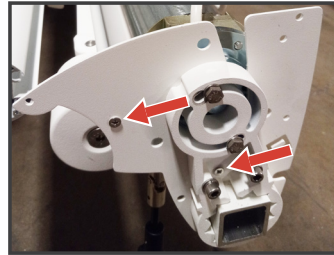
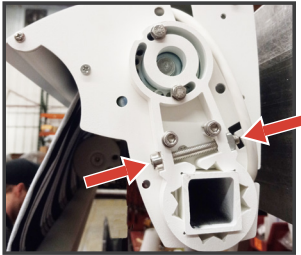

Step #6 Pull out the end bracket, side plate, and motor in order to access the mark made in step 4.

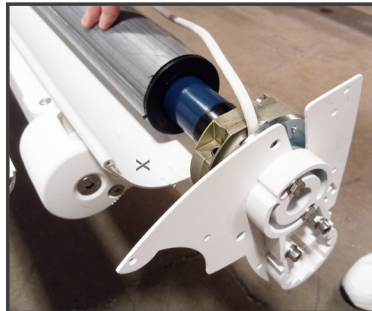

Step #7 With a 1/8" drill bit, make a pilot hole on the mark. Then use a 1/2" to expand the opening in the fabric protector profile.



Step #8 Slide the motor and side plate back into the roller tube and resecure the 2 philips screws and 6mm bolt from step 5.

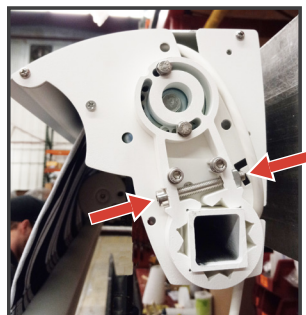
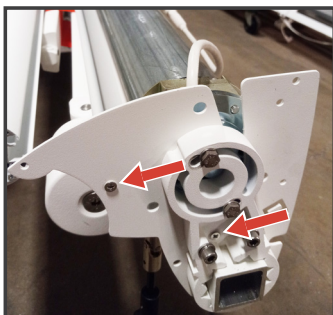

Step #9 Insert the override stem through the fabric protector profile and the motor, and attach the 3mm allen bolt and washers.

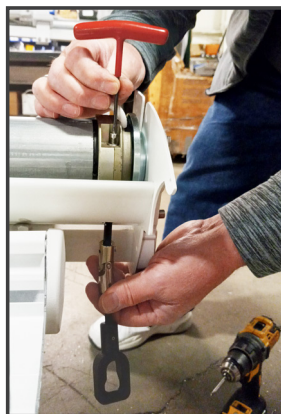
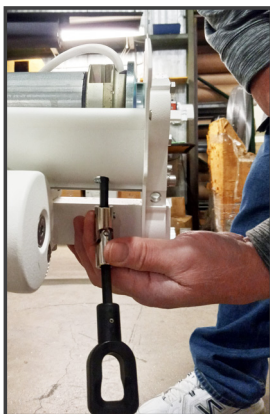

Step #10 Replace the Upper Cassette Profile and the 2 phillips head screws shown here. Repeat this process on the opposite side of the awning if you removed the other side in step 3.

Semi Cassette

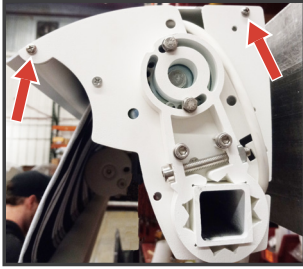

Full Cassette

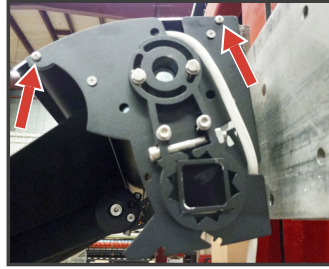

Step #11 Replace the side cover(s) by snapping it in place and replacing the 4mm allen set screw shown here. Gently tap on with a rubber mallet if needed.

Semi Cassette

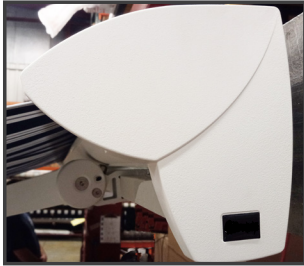

Full Cassette



Note: FULL CASSETTE MODEL ONLY: Measure from the inside of the side plate to the override stem before making the cut on the bottom plate. This will generally be around 2" in length and around 1" in depth. Use a rotary saw to make a notch on the bottom plate profile to make room for the override stem.

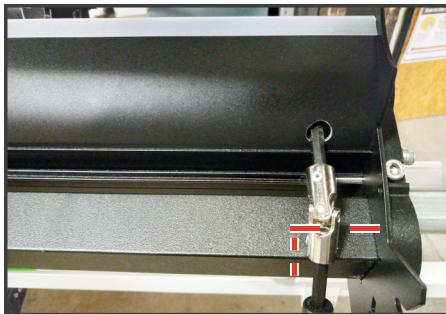

APOLLO

WRIST ADJUSTMENT

APPLIES TO FULL CASSETTE ONLY

► **What to Expect:** A wrist adjustment typically takes 5 minutes to complete.

► **Tools Needed:** • 5mm Allen/Hex Wrench or Socket • 10mm Wrench & Socket • A Step Ladder

Before beginning the process of adjusting the wrists on the APOLLO, it's important to identify the key areas that you'll need to focus on. See Fig.1 and Fig.2 below:

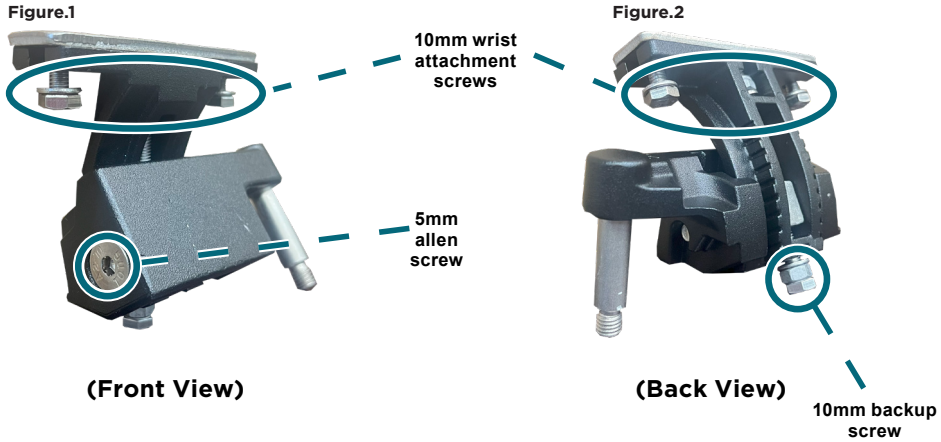

Step #1 The wrist adjustment comes after you set your pitch. Once the pitch adjustment is taken care of, retract the unit fully to see how the unit closes to determine if you need to adjust the front bar. If the front bar is tilting too far forward or too far back, follow these steps.

Step #2 From the fully closed position, extend the wrist about a foot to gain access to the fasteners. Then, loosen the backup 10mm nut on the top (Fig.3) on the bottom of the wrists.

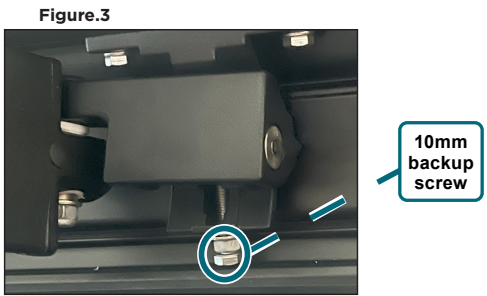

Step #3

Then, loosen the 5mm allen screw (Fig.4) on the side of the wrist in order to begin adjusting the wrist.

Figure.4

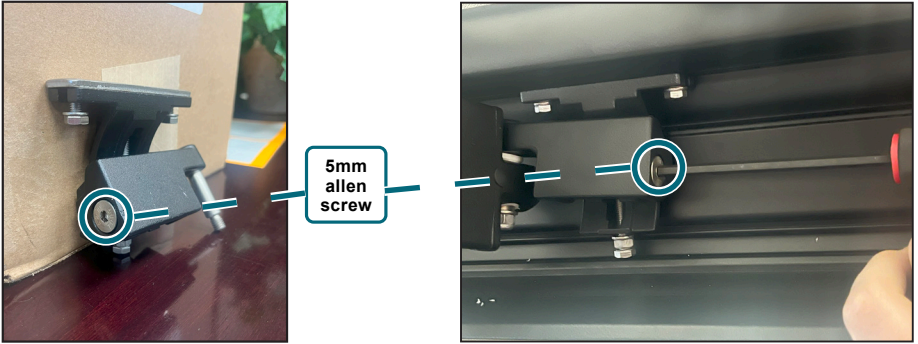

Step #4

Spin the bottom of the 10mm backup nut counter clockwise if the front bar needs to be adjusted in from the bottom, or clockwise if the front bar needs to be adjusted in from the top.

Front Bar all the way in



Front Bar all the way up

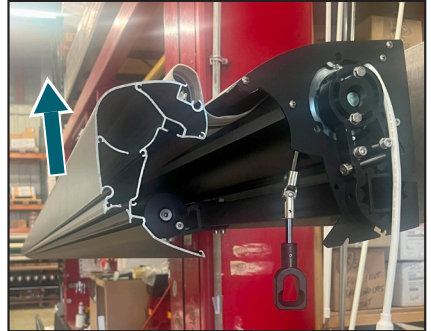

Step #5

After the front bar is adjusted to desired position, retighten the bottom 10mm backup nut (Fig.3) and fully tighten the 5mm (Fig.4) side allen screw.

Step #6

If an arm elbow is not aligned when fully closed, you can make the adjustment with the arm wrist. Carefully loosen the 2 10mm bolts as shown in (Fig.5). DO NOT REMOVE BOLTS. Then, hold the arm elbow & move it to the desired position. This should allow the wrist to slide along the front bar. Once the desired position is confirmed, retighten the two 10mm wrist attachment bolts & test run the unit.

Figure.5

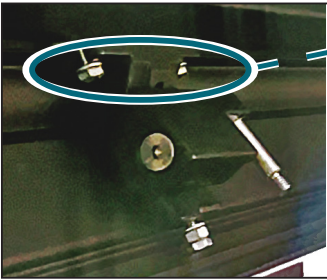

**10mm wrist
attachment
screws**



1-800AWnings.com

ANY QUESTIONS PLEASE CONTACT TECH SUPPORT AT:

800-296-4647

Awning motors are fully tested and the approximate in and out limits are set at the factory. When plugged in for the first time, the awning may extend by itself and then retract.

To change the limits (Sunea RTS & Altus RTS motors):

1. Allow the unit to run to the limit you would like to change and let the unit stop on its own.
2. Press & hold the "UP" and "DOWN" arrows at the same time on the transmitter, the unit will jog once.
3. Move the unit to the desired limit setting, stopping the unit with the "MY" button.
4. Press and hold the "MY" button for one jog - your new limit is set.

PRO TIPS:

► If the unit has a multi-channel Transmitter:

Program all the channels on a multi-channel remote, even if the function(s) is/are repeated. This will save you a service call when the customer calls and states their awning does not work... only to find out the remote is on an open channel.

► Pitch Adjustments:

EVERY unit will need the pitch adjusted/changed once installed. The factory pitch setting differs due to install bracket placement on the factory build rack vs. proper bracket placement once installed. Refer to the model's specific adjustment procedure included with this unit.

► If Hardwiring the Motor:

Awning motors pull a max of 2.2 amps (the electrician will ask). If the unit has a Sunea motor, cut the cord AFTER the quick connect. If the motor has a continuous power cord, cut the cord NO LESS THAN 18" from the motor head. The RTS receiver antenna is located in the first 12 inches of the motor cord. Also, install the junction box ABOVE the motor head to create a drip loop, preventing rainwater from traveling into the head of the motor. (See diagram)

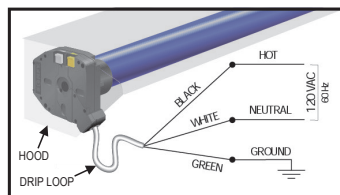

Other conditions that may occur:

Issue:

Plug in the awning's power cord for the first time and it does not work - DID NOT JOG ONCE WHEN PLUGGED IN (if it did, but the transmitter does not respond - see "Jogs once, but no response" on reverse side)

- Check Step #1:
Check the connection at the fast connect on the power cord, if equipped.
- Check Step #2:
Check the plug for adequate power. GCFI outlets can and do, go bad over time. The awning motor load is 2.2 amps, try plugging in a power tool or a hair dryer into the same outlet.
Another option is to run an extension cord to another non GCFI outlet not on the same circuit.
- Check Step #3:
After confirming that you have adequate power, check the light on the transmitter - does the red indicator light up and stay lit for more than 5 second while you hold the "MY" Button? If not, replace the battery (most likely the CR2032).
- Check Step #4:
Press & hold the "UP" and "DOWN" buttons on the transmitter for a single jog - **if it jogs: go through the following steps to programming the motor. (Continued on the next page)**

Programming the motor:

1. Check the direction: UP should retract the awning, if not correct, hold down the 'MY" button for a jog and check again. This is especially important if you have a 3-D wind sensor installed.
2. Bring the awning to the outer limit where you would like it set. Once achieved, press the "UP" and "MY" at same time (awning should start rolling in).
3. Stop the unit with the "MY" button and adjust it to the desired in or fully retracted position.
4. Press the "DOWN" and the "My" buttons at the same to set the in limit (awning should roll out).
5. Check both limits **(you must perform steps 5-7 within 2 minutes).**
6. With the limits where you want them, hold the "MY" button for one jog.
7. Press the programming button on the back of the transmitter for one jog.
8. All limits should be set.

► Check Step #5:

Confirm: (1) There is no power issue, (2) no jog from the motor, (3) Pressing up and down at the same time on the transmitter does nothing... then perform the 2 - 10 - 2 power cut.

Unplug the motor for 2 seconds, plug it back in for 10 seconds, then pull the plug out again for 2 seconds, then plug it back in and leave it in - one of two things will happen:

- A: The motor jogs once... if it does proceed to programming the motor.
- B: Nothing... the motor does nothing, repeat the power cut...it can take up to 10 times.

Issue: Plug in the awning motor cord, it jogs once, but the transmitter does not work.

► Step #1:

Press & hold the "UP" and "DOWN" buttons on the transmitter for a single jog.

► Step #2:

Flip over the transmitter and press and hold the programming button for a single jog.

- The remote limits should function, if not, reset the motor. (See Step #5 above)

Issue: The Awning was working properly and stopped working suddenly.

- The motor has thermal overload protection which can activate after running the motor for more than 4 to 5 minutes. This can especially occur on longer projections. The motor needs to cool down and this could take 15 to 25 minutes depending on ambient temperature.

- Check the CGFI and or breaker to confirm power is still being supplied.

If you cannot resolve these or any other issue, PLEASE CALL US from the job site.

We can talk, FaceTime, or Google Duo with you to resolve the issue and save you a costly future service

call. 1-800Awnings.com: 800-296-4647

Step #1 - programming

Initiate Programming:

Press and hold the “up” and “down” buttons simultaneously until the awning jogs. A jog is a brief movement of the awning.



Step #2a - programming

Confirming the Direction:

Press and hold the down button to confirm the awning moves outwards.



Step #2b - programming

Confirming the Direction:

If this is not the case, press and hold the “my” button for two seconds until the awning jogs. The direction is now corrected.



Step #3 - programming

Setting the Inner Limit:

Move the awning to the desired inner limit by pressing and holding “up”. Release when the inner limit is reached.



Step #4 - programming

Setting the Outer Limit:

Press and hold “my” and “down” until the awning begins to move out, then release. Use “my” to stop it at the desired outer limit.



Step #5a - programming

Confirming Your Limits:

Press and hold “my” and up until the awning begins to move in, then release. Immediately press “my” to stop the awning.



Step #5b - programming

Confirming Your Limits:

Press and hold “my” until the awning jogs.



Step #6 - programming

Exiting Programming Mode:

Press and hold the program button on the back of the remote until the awning jogs.



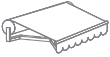

Setting for Standard Awning : Manual Up and Down Limits

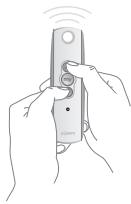

STEP 1
Initiate programming by pressing both the (Up) and (Down) buttons at the same time until the motor jogs.



STEP 2
Check the direction of operation. Press and hold the button and confirm it moves the motor out (the motor will be in momentary fashion). To change the direction press and hold the (Stop) button until the motor jogs.



STEP 3
Bring the motor to your desired upper limit. Press and hold both the and buttons until the motor begins to move down, then release. Stop the motor where the lower limit should be set, you can adjust by pressing the or buttons.



STEP 4
Press and hold the and buttons until the motor begins to move up. The motor will stop at the original upper point. Adjust if necessary.



STEP 5
Press and hold the button until the motor jogs to confirm the limit setting.



STEP 6
Press and hold the Program button on the back of the transmitter until the motor jogs. It will now operate in a maintained fashion. Double check limits as a precaution.

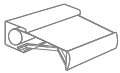

Setting for Cassette Awning: Automatic Up Limit

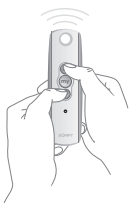

STEP 1
Initiate programming by pressing both the (Up) and (Down) buttons at the same time until the motor jogs.



STEP 2
Check the direction of operation. Press and hold the button and confirm it moves the motor out (the motor will be in momentary fashion). To change the direction press and hold the (Stop) button until the motor jogs.

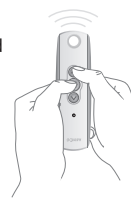

STEP 3
Bring the motor to your desired down limit. Press and hold both the and buttons until the motor begins to move up, then release.



STEP 4
Press the button and stop the awning halfway



STEP 5
Press and hold the button until the motor jogs to confirm the limit settings. The motor will then automatically set its inner limit.



STEP 6
Press and hold the Program button on the back of the transmitter until the motor jogs. It will now operate in a maintained fashion. Double check limits as a precaution.

► **What to Expect:** Installing and programming an Eolis 3D Wind Sensor typically takes about 15-20 minutes. Batteries and mounting screws are included.

► **Tools Needed:** • A Drill with a Phillips Bit • A Small Screw Driver

Step #1 Extend the awning fully.

Step #2 Ensure that the arrow is pointing up as indicated when installing the mounting plate.

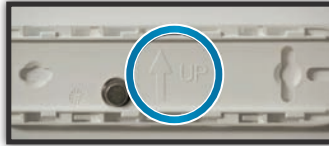

Step #3 Adhere the mounting plate with in place with the double sided tape provided, while you permanently mount it to the arm with the self-tapping screws provided. Placement varies based upon awning style. Check our wind sensor installation guides based on awning type to learn more about where to mount the sensor.



Programming an Eolis 3D Wind Sensor

Step #1a - programming Identify the Direction of your Awning. The [Down] button should extend/move the awning outward.

Step #1b - programming Stop the awning after a few inches by pressing the [my] button.

Step #1c - programming If the [Down] button is retracting the awning, Review the 'How to Change the Direction of an RTS Motor' video.

Step #2 - programming

Remove the sensor from the housing using a small screwdriver.

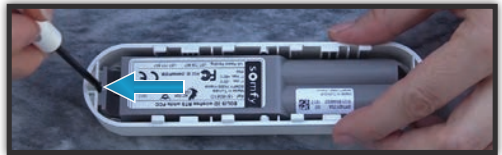

Step #3 - programming

Install the AAA batteries and confirm that the indicator light blinks (red or green depending on newer versions).



Step #4 - programming

Press the [programming] button on the back of the remote until the awning jogs.



Step #5 - programming

Press the [programming] button on the Eolis sensor until the awning jogs again.



Step #6 - programming

Place the sensor back into the housing.



Step #7 - programming

Make sure the cover and arrow are in the same orientation and slide the cover onto the mounting plate. Until it clicks.



Testing Functionality

Step #4a Test the sensor by pushing up and down on the front bar until the arms begin to retract.

Step #4b You can stop the awning after 5 seconds and try a second test to be sure that the sensor is working as desired.

Step #5

Adjust the sensitivity level if needed, Factory setting is 2. DO NOT exceed setting 4. (1 = Most sensitive, 9 = Least sensitive)

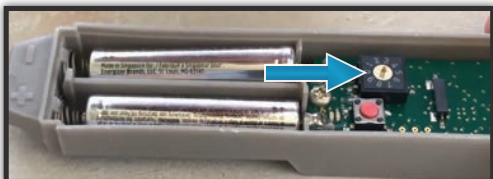

Common Troubleshooting Issues Including: Operation, Sensor Sensitivity, and Battery Issues

Issue: Is the awning automatically retracting every 30 to 60 minutes and no wind is present?

If yes, follow these steps:

- ▶ Step #1: Try moving the wind sensor.

Slide the sensor housing off from the mounting plate.

Move the wind sensor closer to the motor, and move the front bar up and down until the awning retracts.

If this does not solve your issue, move to step #2.

- ▶ Step #2: Replace the batteries. You will need two AAA alkaline batteries and a small screwdriver.

Remove the sensor from the housing using a small screwdriver.

Replace the two AAA batteries and confirm that the sensor light blinks. (red or green depending on newer versions.

Assuming that this solves the issue, place the sensor back into the housing and slide the sensor back into place on the mounting plate until it clicks.

If you are still experiencing issues, please contact technical support for further assistance. Call: 800-296-4647

≡ IMPORTANT NOTES

⚠ This guide is intended for professional installer use.

⚠ Retractable awnings are under extreme spring tension and can be dangerous. Be sure to review

▶ the owner's guide with the homeowner.

▶ Register your warranty here: www.1800Awnings.com/home/warranty-registration/

▶ Follow the link labeled "Click to access the warranty registration form".

▶ Enter your order number and select your dealer.

RETRACTABLE AWNING INSTALLATION RESOURCE GUIDE

